



Fox Delta

Amateur Radio Projects & Kits

FD- AAZ-0914A

AAZ-0914A USB, Blue tooth and Graphic CPU 50MHZ Antenna Analyzer

AAZ- 0914A KIT: USB Standalone, Blue tooth standalone and Graphic CPU capable 50MHZ* Antenna Analyzer

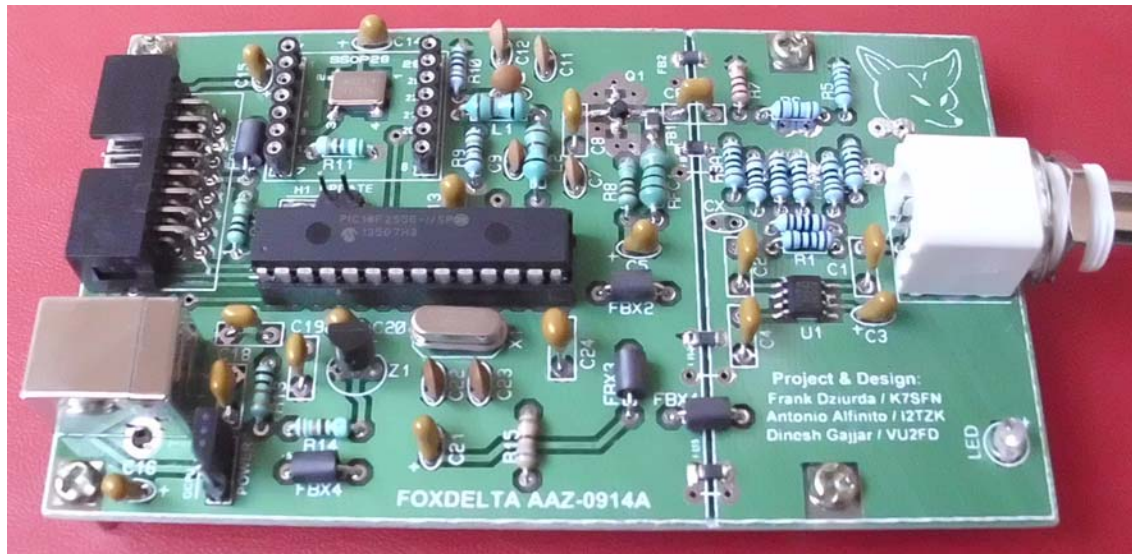

* = Most DDS AD9850 chips will go to 65MHZ.

50MHZ Antenna Analyzer: AAZ-0914A:

AAZ-0914A is based on our last popular kit: AAZ-0713A with added ability to use HC-05 type Blue tooth module by simply plugging it into this board at FRC16 Connector. Firmware is updated to V6.01 which works with 5.03 PC Software.

Originally designed to work as a standalone USB Antenna Analyzer like AAZ0713A, it has capability to accept add-on Blue tooth module to send data to smart phones. Similarly, it also works with a Graphic CPU LCD Display using a small breakout board.

Breakout board also provides a 5PIN header interface for use with our next project: Stepper Motor Loop Antenna Controller, which is being developed by I2TZK. (Coming soon)

Firmware for Graphic CPU and Antenna Analyzer – 0713A/0914A is developed by [Tony/I2TZK](#).

Design Basics:

AAZ-0914A is a simple single board antenna analyzer using DDS signal as a source and a return signal from antenna for measurement by a Log Amplifier AD8307. PIC18F2550 process the received data and send to PC/Blue tooth/GCPU for display.

AAZ-0914A is an "INFINITY" Add-on:

"INFINITY" Project is developed keeping in mind that we use same CPU/LCD/Hardware for various Purposes or Projects, saving a lot of money in hardware. AAZ-0914A is an "Infinity" add-on. It interfaces to GCPU thru the breakout board supplied with kits.

AAZ-0914A may be used as:

1. A Standalone USB Antenna Analyzer
2. Graphic CPU Display for your data using: GCPU-0613
3. Antenna Analyzer for your Smart Phones (with Blue tooth Module Installed)
4. Loop Antenna Tuner with Stepper Motor Controller.

1. Using AAZ-0914A with GCPU:

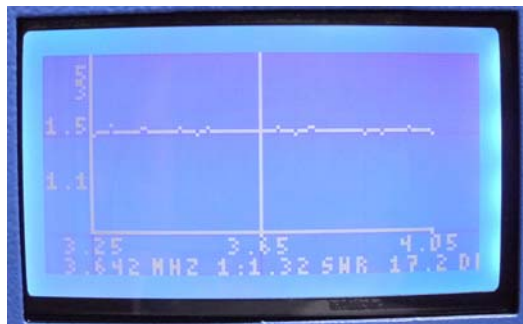

Graphic CPU - 0613 is not a part of AAZ-0914A kits.

You may buy it separately, if you like to use it.

If you own a Graphic CPU and want to view AAZ-0914A data, you may connect your GCPU Male to male D9 cable to the Breakout board available for AAZ-0914A.

2. USB Antenna Analyzer:

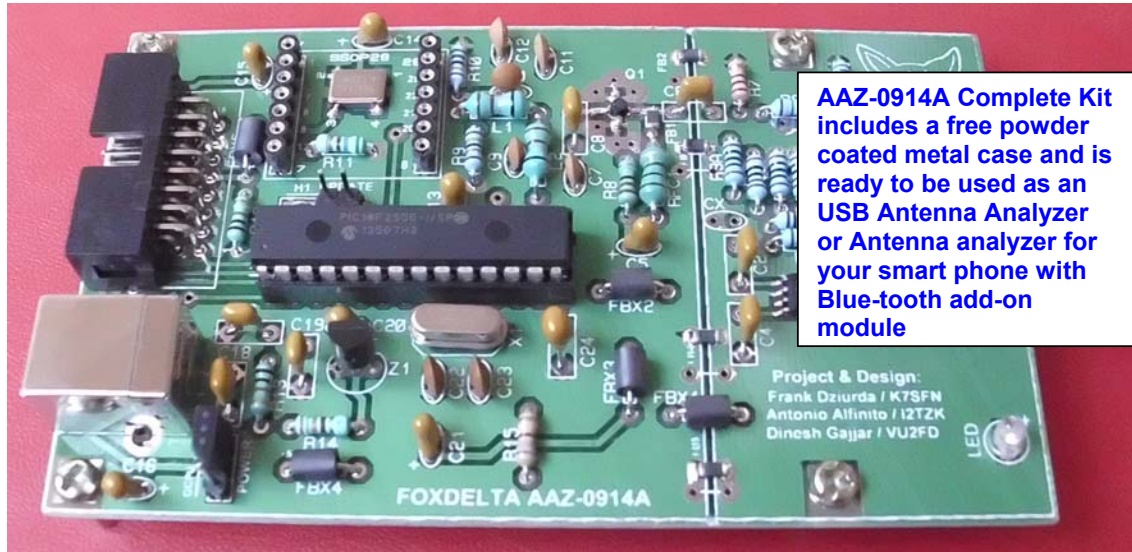

USB Connector Connect to your PC: Supply 5V to AAZ-0914A and establish communication with your PC

3. Blue-Tooth Activation:

A small FRC16 Connector (MPIO or Multi-purpose input output connector) on AAZ-0914A accepts a plug-in Blue tooth module available as an option.

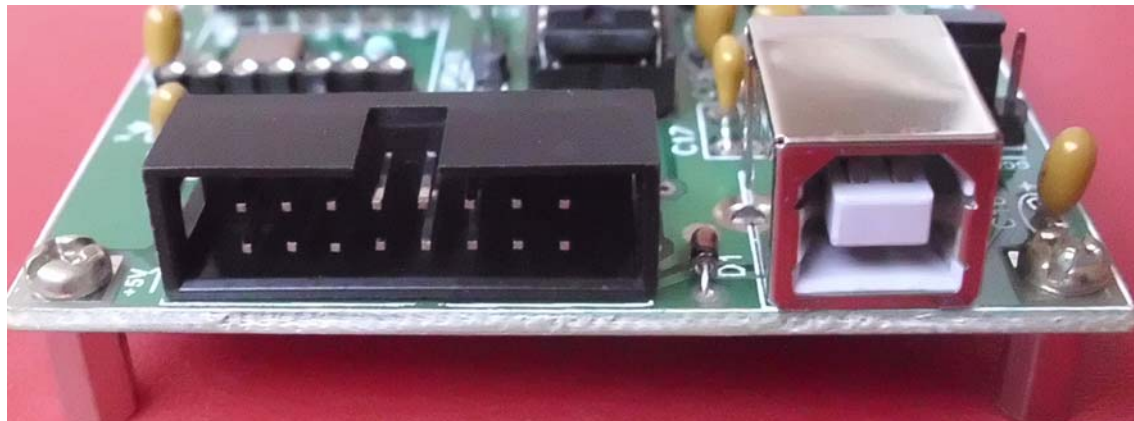

Blue Tooth function is activated by simply installing BT add-on Module at the FRC16 Connector of AAZ-0914A. No other config is required.

Powering AAZ – 0914A:

AAZ-0914A has two powering Options.

- 1. You may connect your PC to power AAZ-0914A**
- 2. Connect to GPCU thru supplied Breakout board Kit. Select “POWER” header on AAZ board to “GPCU”.**

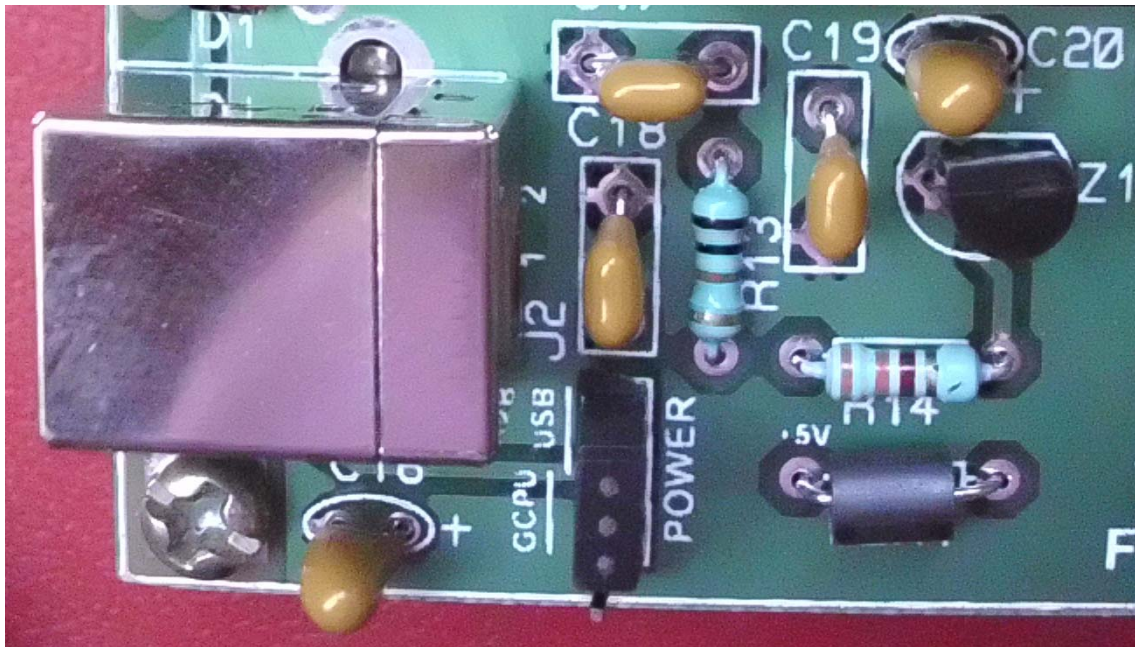

Install a shorting pin at “USB” for USB operation. Install at “GCPU” when GCPU is connected to AAZ-0914A thru a Breakout board.

AD9850 DDS Assembly:



DDS: AD9850 or 9851 will be supplied with kits. (Pre-Soldered and fully tested)

Solid Pin Header Male/Female are supplied for easy removal of this module in case of damage.

3.3V Power to 125MHZ OSC and Blue-tooth module:

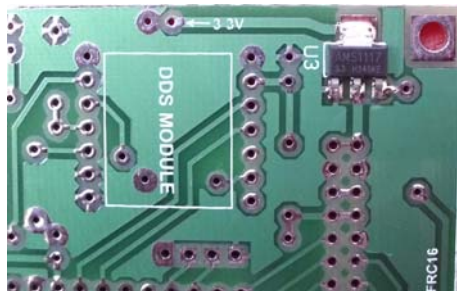

AMS1117-3.3V is a 3.3V 1A LDO type regulator which supply power to 125MHZ SMT Oscillator and external Blue-tooth module

This regulator is pre-soldered for kits.

PC (USB) or Blue-tooth Interface Selection:

AAZ-0914A selects USB or BT operation automatically:

1. For BT operation, insert BT adapter on MPIO Socket.
2. For USB operation, remove BT module from MPIO Socket.

AD9850 / AD9851 Selection:

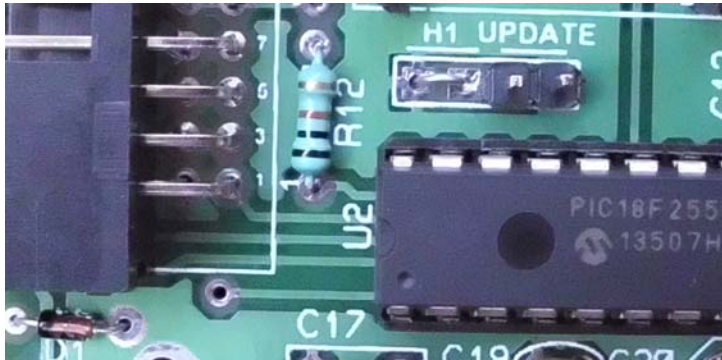

Header H1 selects: Ground = AD9850, Open = AD9851

H1 may be permanently grounded by a wire instead of a header instead of a shorting-pin if DDS module is going to be only AD9850 (This Kit).

FW Update Header:

AAZ-0914A kit is supplied with V6.01 Firmware pre-loaded on PIC18F2550. Firmware has a boot-loader built-in, which can be activated by shorting "Update" header to update PIC firmware (PIC Programmer is not required)

AAZ-0914A PCB with Pre-Soldered SMT Parts:

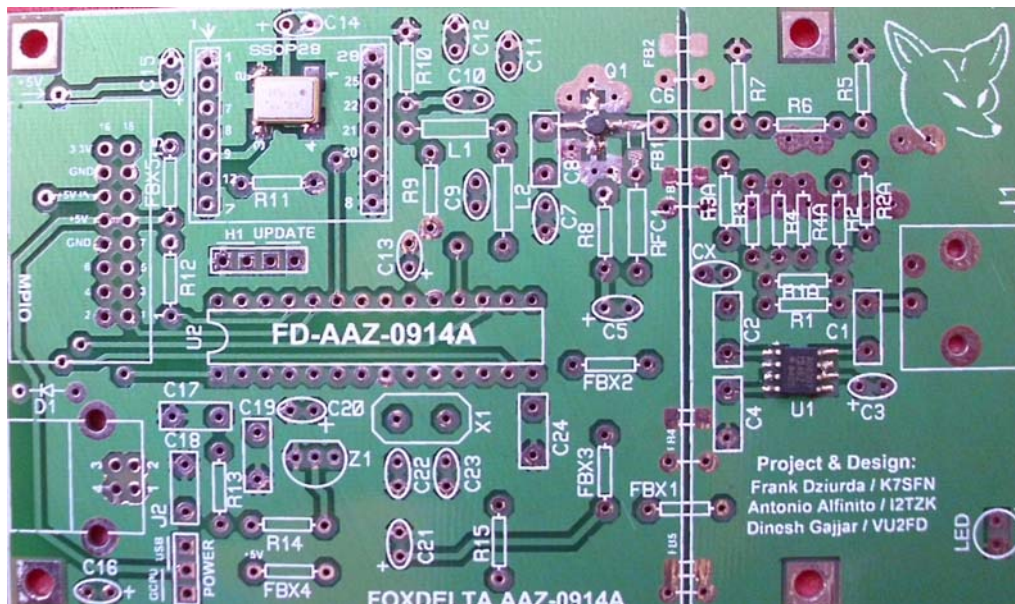

Ferrite Beads and AD8307:

AAZ-0914A has 5 Ferrite beads in 1206 size:

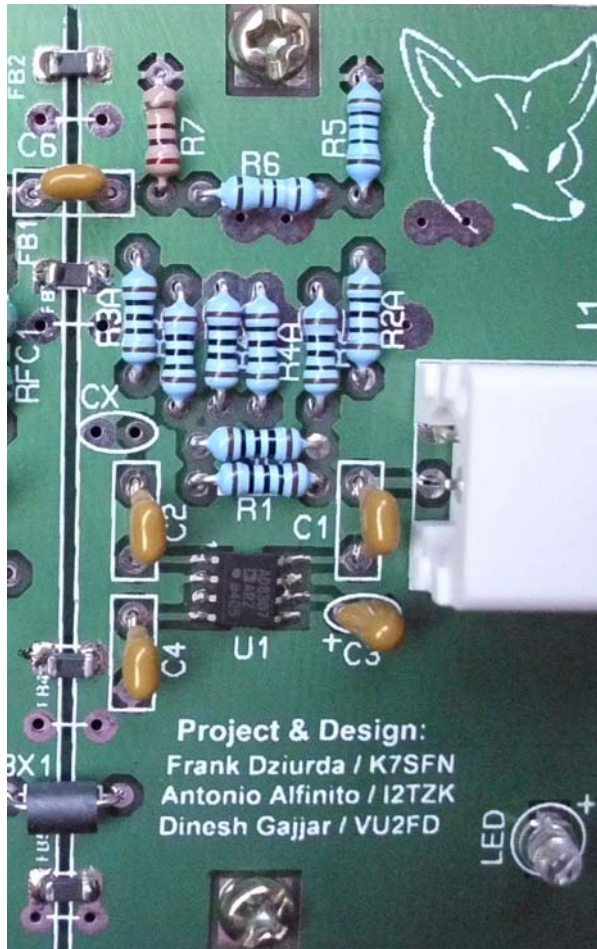

4 Ferrite beads (FB1-4) used as ground plane separator are Pre-Soldered on PCB for kits

Kit has AD8307 Pre-Soldered on PCB.

Ferrite Bead on Q1:

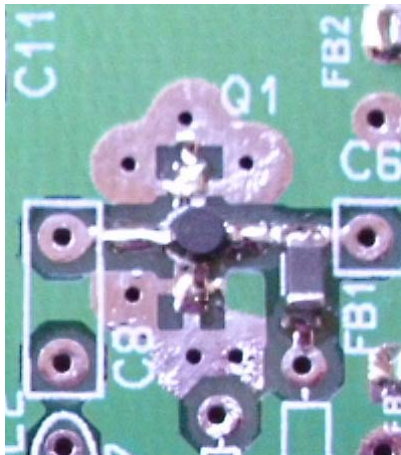

FB1 is a Ferrite Bead in size 1206/SMT. This and Q1 are supplied Pre-Soldered on PCB.

AAZ – 0914A KIT Parts List:

Quantity	Part ID	Part Details
1	U2	PIC18F2550 FW V6.01
1	AD9850 Adapter	AD9850 & SMT Caps
1	U1#	AD8307 SO8 Pre-Soldered on Board
1	OSC#	125MHZ SMT OSC 3.3V SMT
1	X1	20MHZ Crystal HC49
1	LED	3mm LED
1	Q1#	SGA3486
1	IC Socket	28PIN DIP
1	PCB	FD-AAZ-0914A DSPTH PCB
1	Z1	LM385-2.5V
1	U3#	AMS1117 – 3.3V
2	L1, 2	HF LPF Inductors 0.22uH
4	FBX1, 3, 4, 5	Ferrite Bead Inductors
2	RFC1, FBX2	100uH RFC
1	J2	USB Socket, R/A, PCB Type
5	FB1#, 2, 3, 4, 5*#	Ferrite Beads 1206 SMT
1	FRC16 R/A Socket	Multi-Purpose Input Output Extension
1	J1	BNC R/A PCB
2	“Update” & H1	2PIN Header
1	D1	1N4148 Diode (Polarity Protection)
All Resistors ¼ W 5%		
1	R5	300 Ohms
1	R6	18 Ohms
1	R7	270 Ohms
8	R1/A, R2/A, R3/A, R4/A	100 Ohms
1	R8	33 Ohms
1	R9	24 Ohms
1	R10	51 Ohms
2	R12, 13,	10K
1	R11	5.6K
1	R14	3.3K
1	R15	680 Ohms
Capacitors		
1	C24	0.47uF
2	C17, 19	.001uf Poly
6	C1, 2, 4, 6, 8, 18,	.1uf Poly
6	C3, 5, 15, 13, 16, 21	1uf Tantalum
2	C23, 22	18pf
2	C 20, 14	10uF Tantalum
1	C7	82pf Ceramic
2	C10, 9	15pf Ceramic
1	C12	47pf Ceramic
1	C11	100pf Ceramic

Note:

1. “Update” = Firmware Update Header

2. # = Parts Pre-soldered

* = FB1 is 1206 SMT Bead. FB2-FB5 may be STND beads or SMT

AAZ-0914A COMPONENT SIDE SILK:

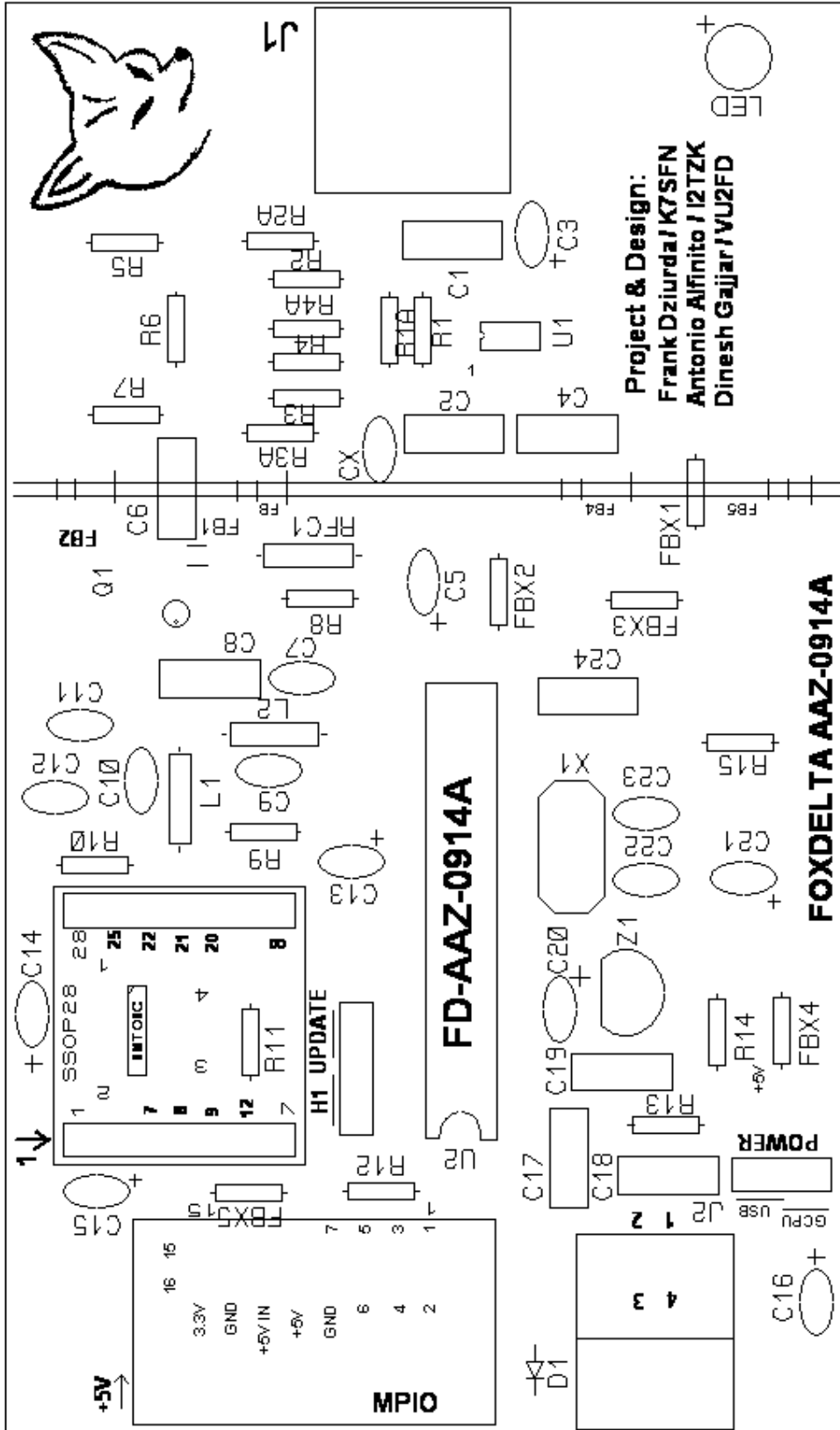

Component Side Silk:

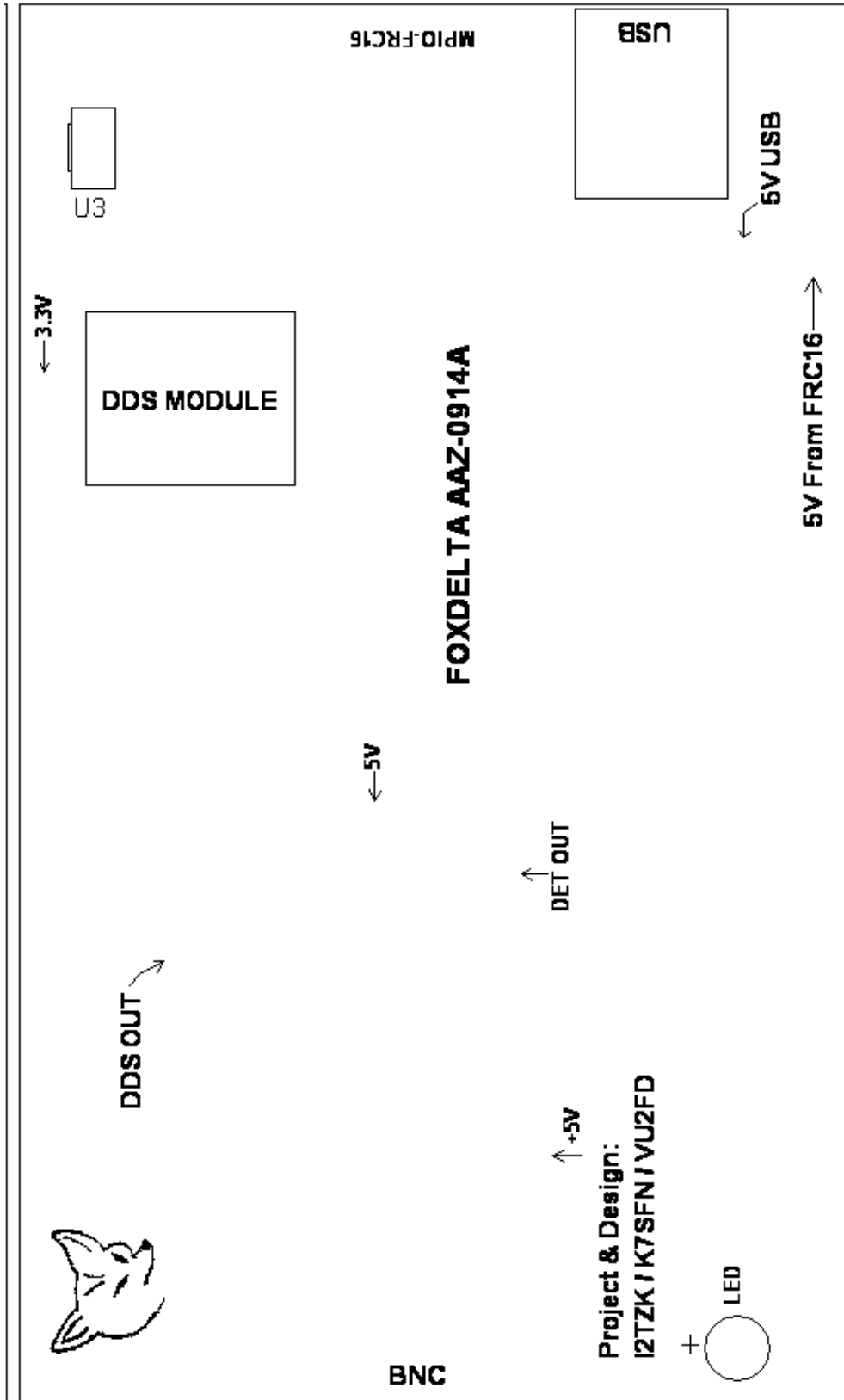

We have one SMT part on this side of board: U3. (Pre-soldered)

AAZ-0914A Schematic:

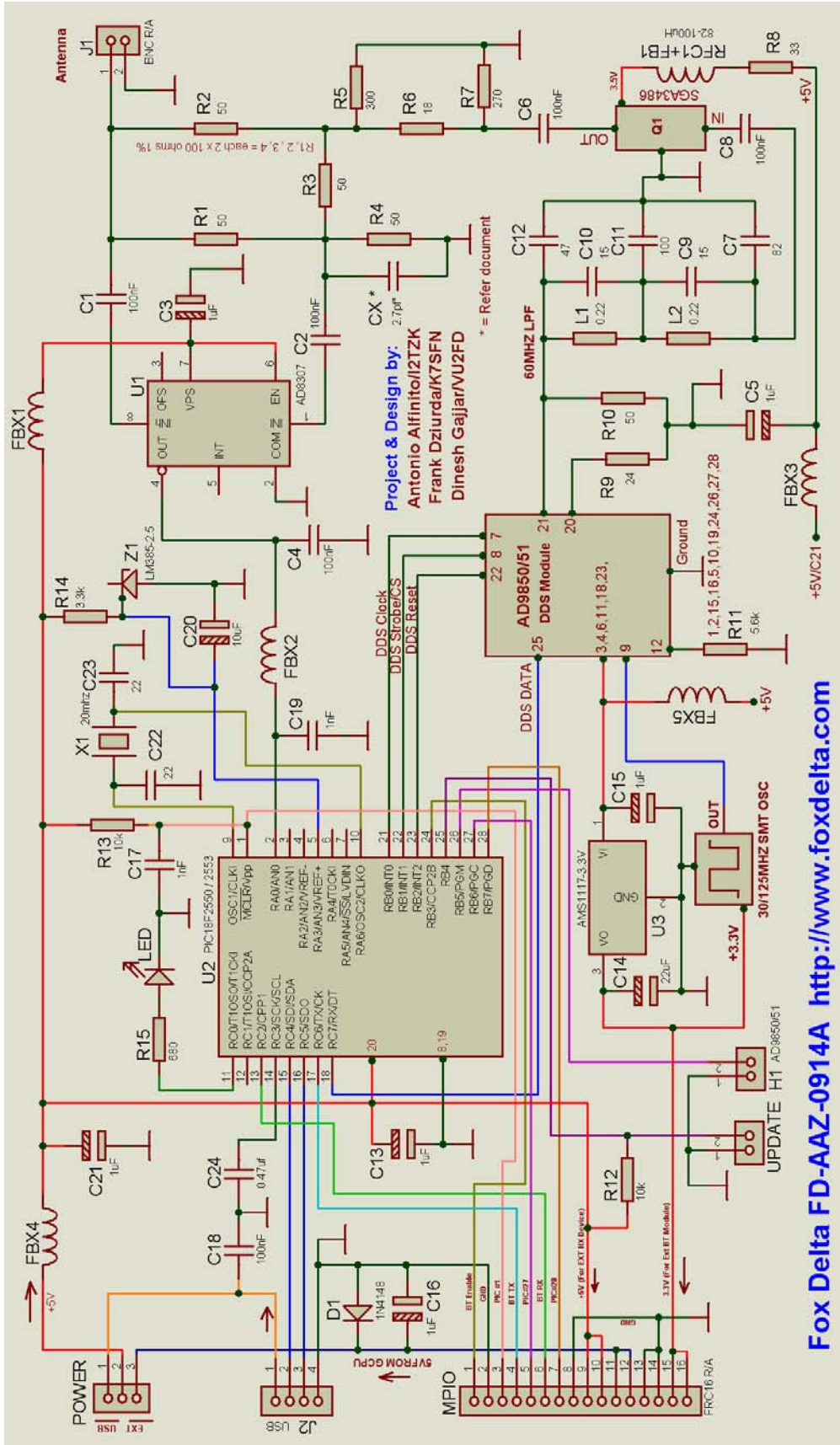

Graphic CPU Interface and Blue-Tooth Modules:

Soon, a breakout board to interface GCPU will be available. Breakout board will be also useful for future add-on Antenna Tuner Project.

Blue-tooth module kit will be available soon after release of this project kit. Module simply plugs into FRC16 socket.

Inserting BT module into FRC16 Socket automatically activates blue-tooth function in AAZ-0914A. No config or jumpers required.

Optional add-on Board/Modules:

Blue tooth module uses HC-05 module

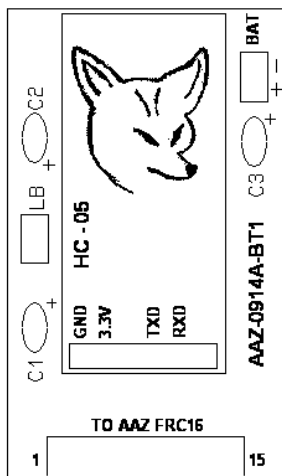

Break-out Board

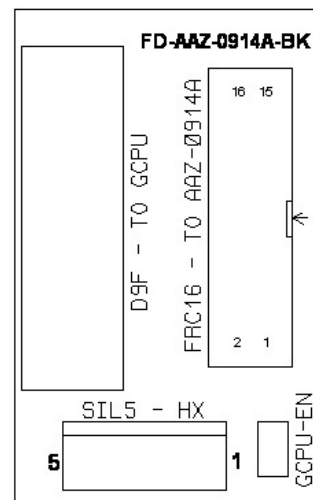

Only one mode is possible: Blue-tooth / GCPU or USB.

73s

Dinesh Gajjar

20th November 2014

For more details, please visit Project Page: <http://www.foxdelta.com>